

Electrical Specification

Parameter	Specification	Unit
Center Frequency	2125	MHz
Bandwidth (1dBBW)	F0±70[2055~2195]min.	MHz
Insertion Loss in BW	2.0 max.	dB
Ripple in BW	0.5 max.	dB
VSWR in BW	1.5 : 1 max.	Ratio
Attenuation (Relative Value)	40 min.@1770 MHz	dBc
	30 min.@1980 MHz	
	40 min.@2400 MHz	
	65 min.@2610 MHz	
Impedance	50	ohm
Operating Temperature	-40 to +85	°C

Outline Drawing

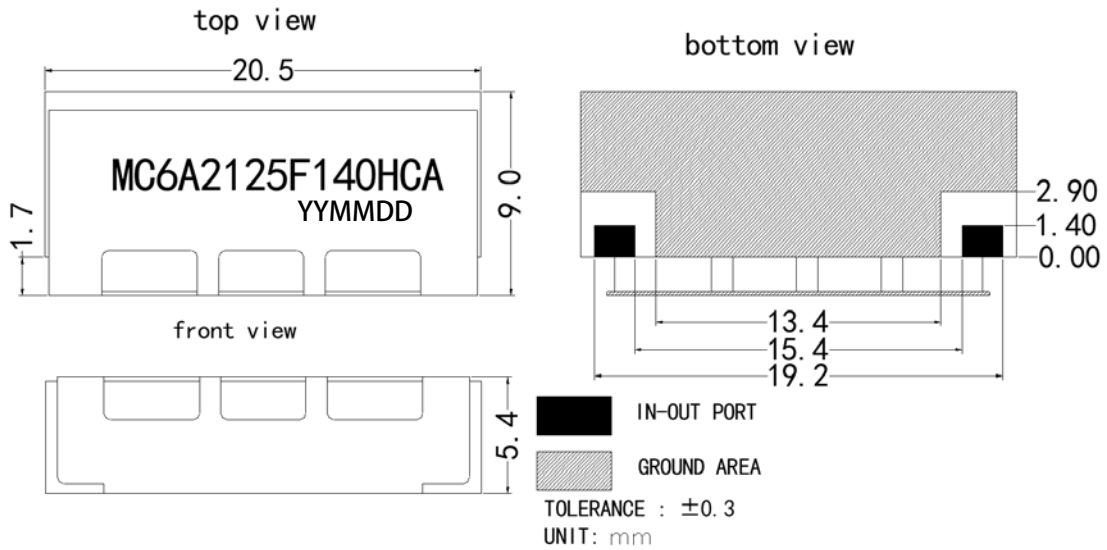

Recommended PCB Layout

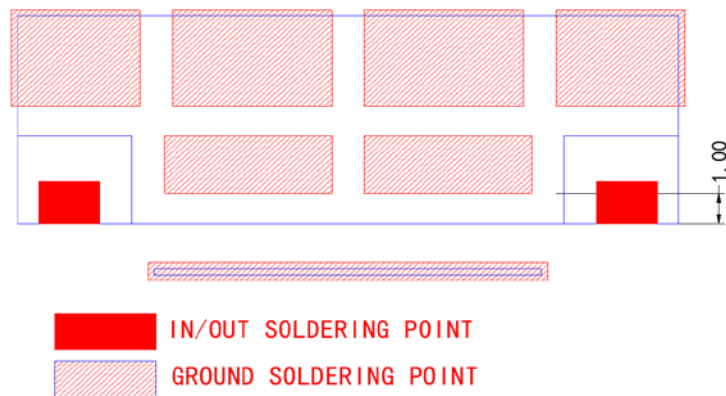

Remarks: Recommend to use silver-containing solder paste

Application Instructions:

1. Recommended Soldering Temperature

a. Containing Pb Soldering,

Recommend the solder paste of melting points 183°C, soldering temperature won't exceed 230°C. Refer to the below reflow soldering profile.

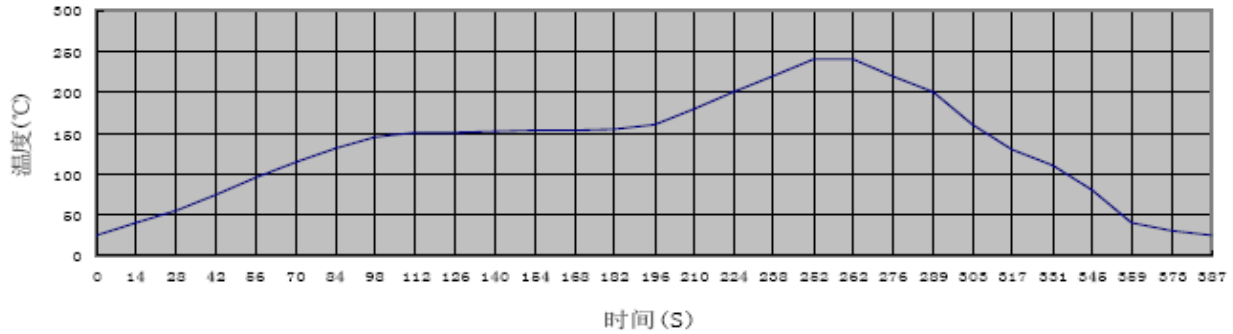

b. Pb-free soldering

Recommend the solder paste of melting point 217°C, soldering temperature won't exceed 260°C. Refer to the below reflow soldering profile.

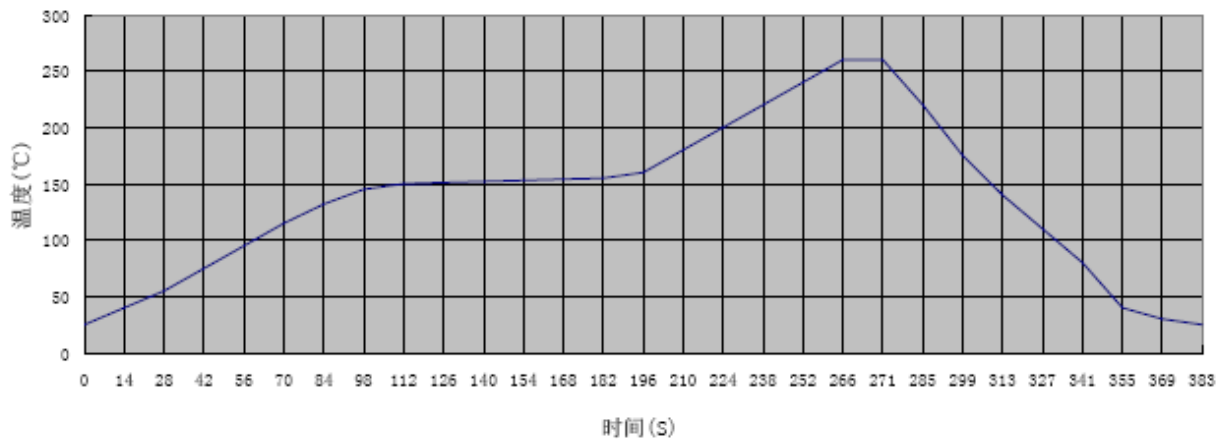

2. PCB layout for soldering the filter should be designed in grid pattern. Refer to recommended PCB Layout for more details. Soldering Area is 50%-70% of ground area of this filter.

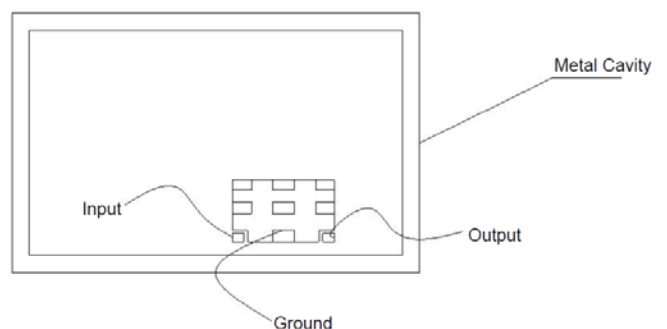
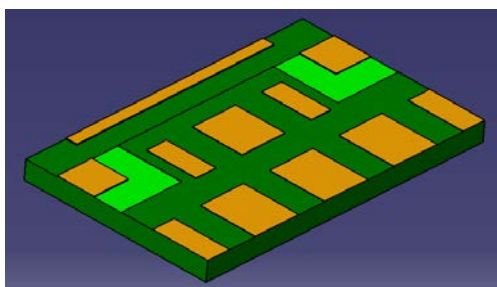

3. This filter should be soldered 2mm (at least) away from metal cavity, in order to avoid degrading filter's performance by metal cavity. Refer to the below figure.

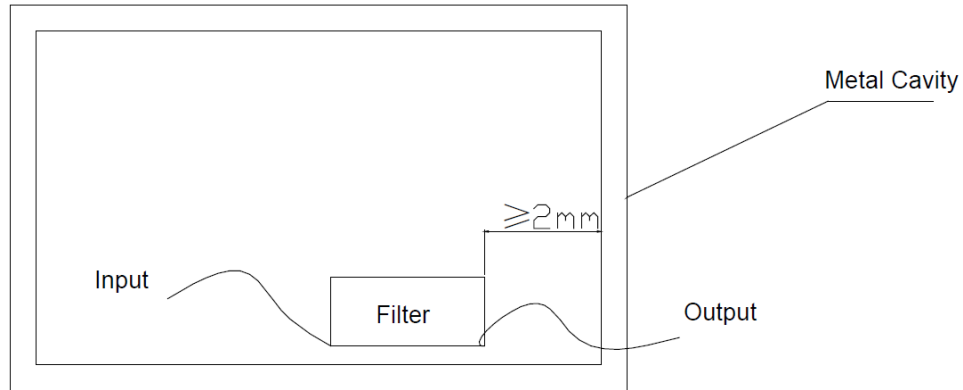

4. It would achieve better performance that the top of the filter is grounded too.
5. Mounting screws around the filter should be 1cm away from the filter.
6. To avoid PCB transformation during mounting the filter.
7. If customer will solder PCB of the filter on Aluminum plate, please contact us directly.