

Electrical Specification

Parameter	Specification	Unit
Center Frequency	3100	MHz
Bandwidth (BW)	F0±225[2875~3325]	MHz
Insertion Loss in 2900~3100MHz	0.9 max.	dB
Ripple in BW	0.5 max.	dB
Group Delay Variation in BW	1 max.	ns
Return Loss in BW	14 min.	dB
Input Power	15 max.(100 peak)	W
Attenuation (Absolute Value)	30 min.@2250MHz	dB
	20 min.@2700 MHz	
	20 min.@3600~5000 MHz	
Impedance	50	ohm
Operating Temperature	-40 to +85	°C

Outline Drawing

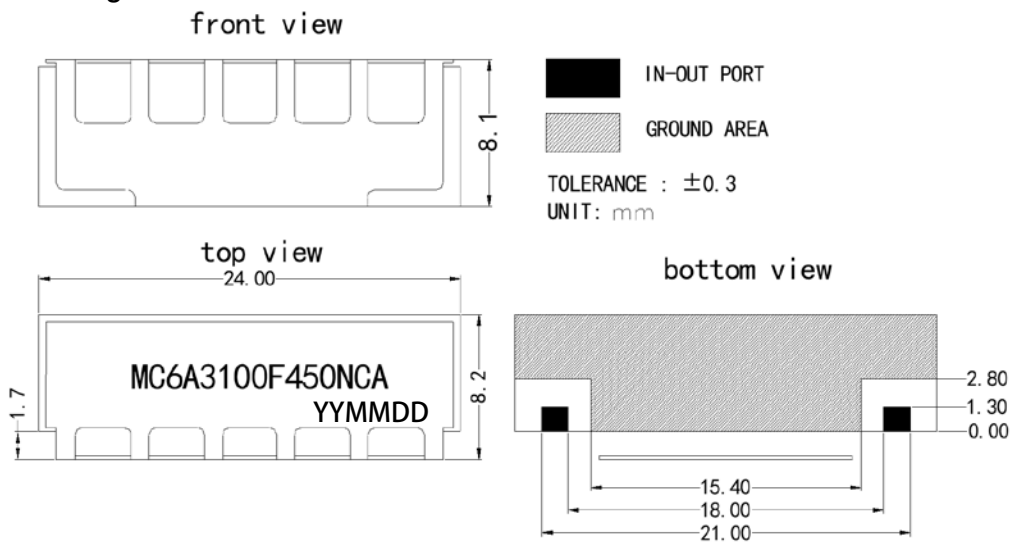

Recommended PCB Layout

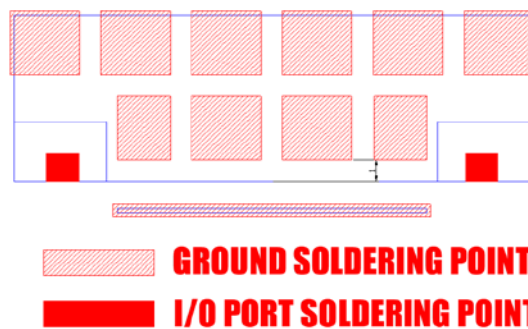

Remarks: Recommend to use silver-containing solder paste

Application Instructions:

1. Recommended Soldering Temperature
 - a. Containing Pb Soldering,
Recommend the solder paste of melting points 183°C, soldering temperature won't exceed 230°C. Refer to the below reflow soldering profile.

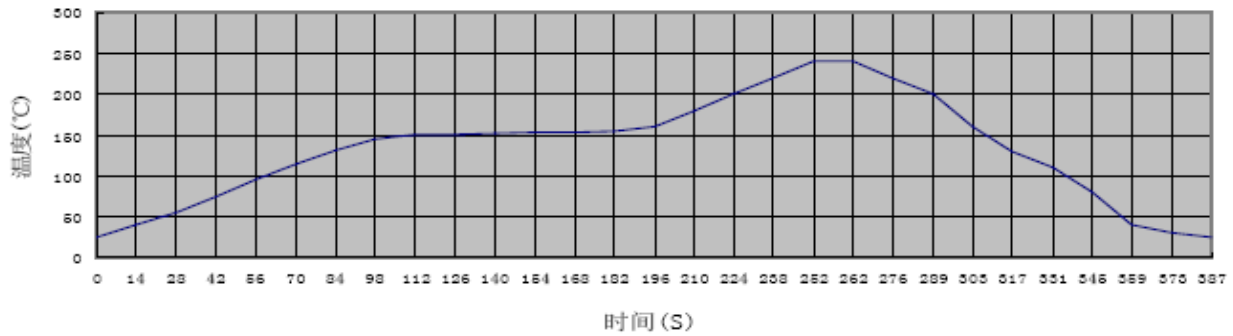

- b. Pb-free soldering
Recommend the solder paste of melting point 217°C, soldering temperature won't exceed 260°C. Refer to the below reflow soldering profile.

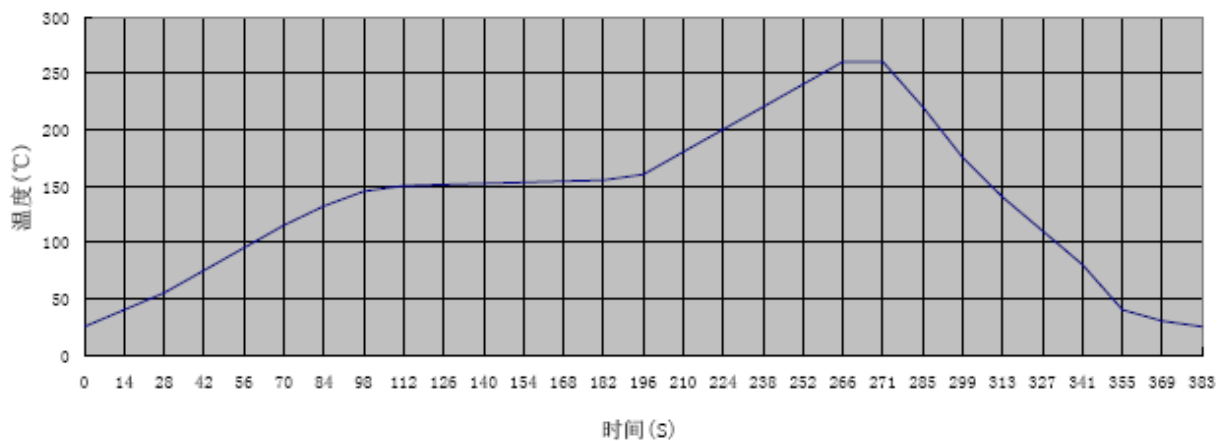

2. PCB layout for soldering the filter should be designed in grid pattern. Refer to recommended PCB Layout for more details. Soldering Area is 50%-70% of ground area of this filter.

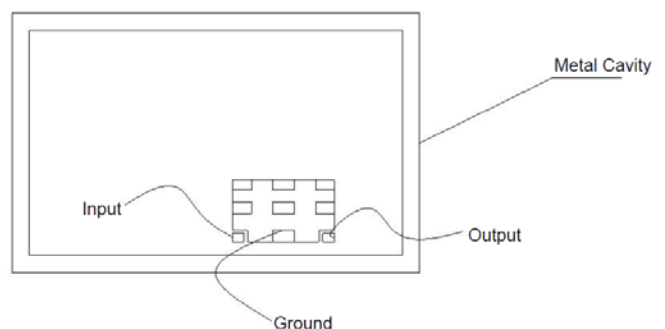
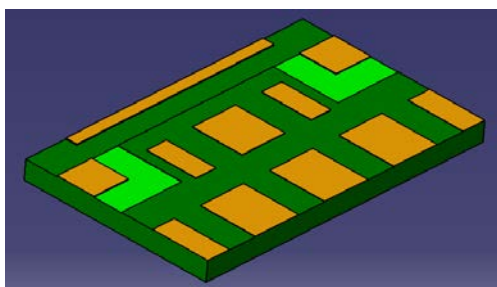

3. This filter should be soldered 2mm (at least) away from metal cavity, in order to avoid degrading filter's performance by metal cavity. Refer to the below figure.

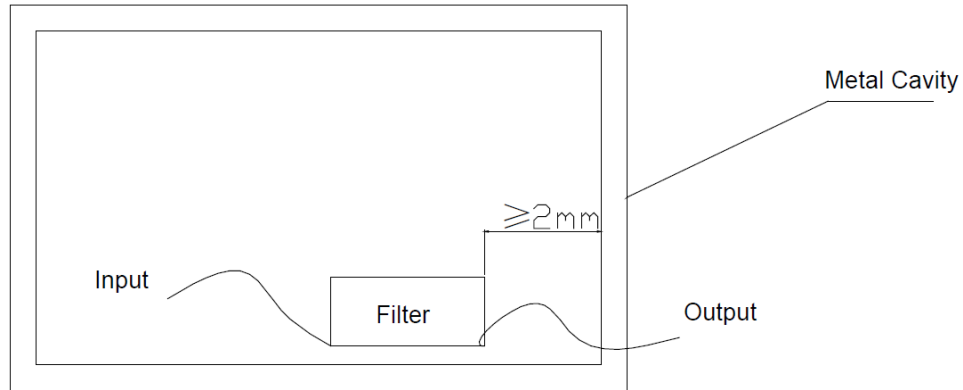

4. It would achieve better performance that the top of the filter is grounded too.
5. Mounting screws around the filter should be 1cm away from the filter.
6. To avoid PCB transformation during mounting the filter.
7. If customer will solder PCB of the filter on Aluminum plate, please contact us directly.