

Performance

- Dual paths output: $F_0=7.0\sim 8.6\text{GHz}$
 $F_0/2=3.9\sim 4.3\text{GHz}$
- Output Power: +11dBm
- Noise figure: -109dBc/Hz @ 100KHz Typ
- Chip size: 2.5*1.6*0.1mm

Function Diagram

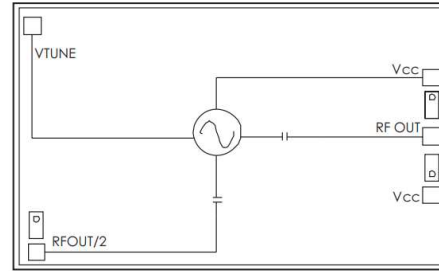

Electrical Specifications (Ta=+25°C, Vcc=+5V)

Parameter		Min	Typical	Max	Unit
Frequency Range	F0	7.8~8.6			GHz
	F0/2	3.9~4.3			GHz
Output Power	RFOUT	9	11	14	dBm
	RFOUT/2	5	8	11	dBm
Noise figure@100KHz, VTUNE=+5V@RFOUT		-	-109	-	dBc/Hz
Tuning Voltage		2	-	13	V
Harmonics	1/2	-	-35	-	dBc
	2 nd	-	-13	-	dBc
Frequency Pulling (12dB RL)		-	8	-	MHz
Pushing Frequency Factor @ VTUNE=5V		-	12	-	MHz/V
Frequency Shift		-	0.7	-	MHz/°C
Operating Current		145	180	215	mA

Test Curves (Die chip test)

Output Freq vs. Tuning Voltage, TA=+25°C

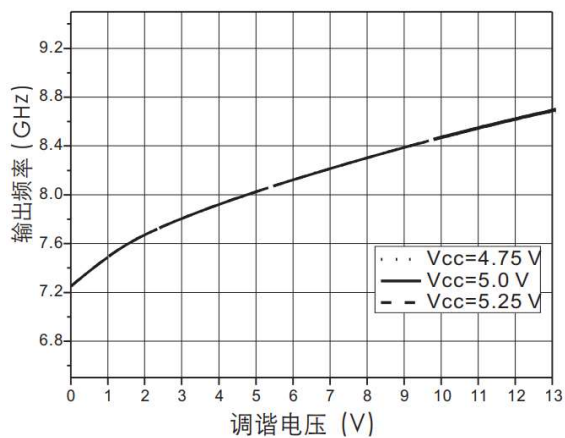

Output Freq vs. Tuning Voltage, Vcc=+5V

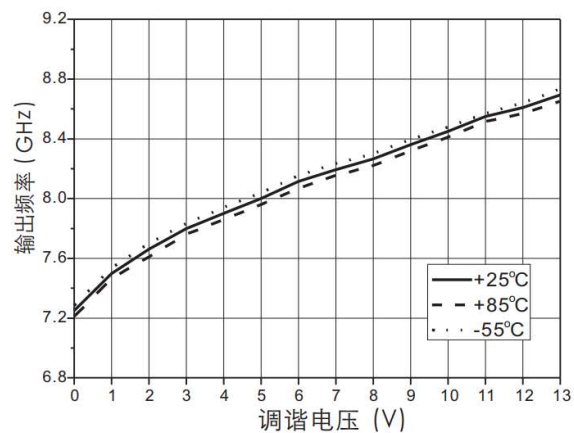

Electronic tuning sensitivity vs. Tuning Voltage
Vcc=+5V

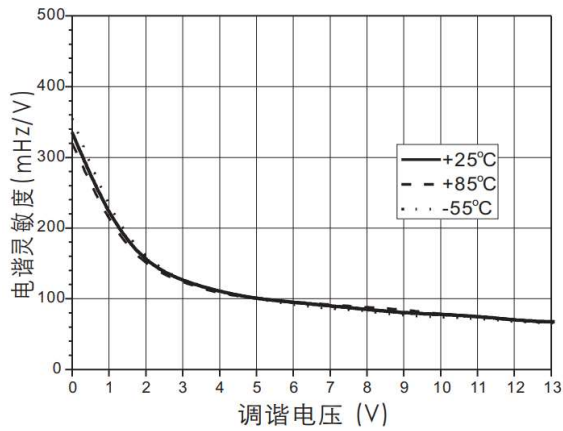

Output Power vs. Tuning Voltage, Vcc=+5V

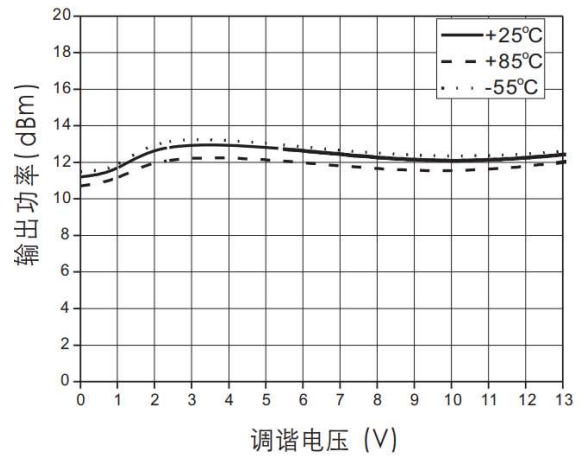

SSB Noise Figure vs. Tuning Voltage

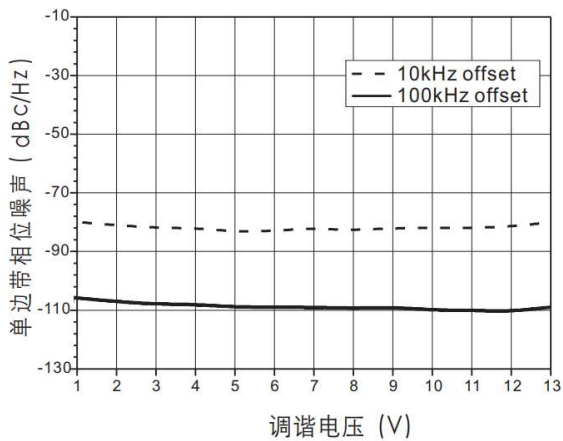

SSB Noise Figure vs. Vtune=+5V

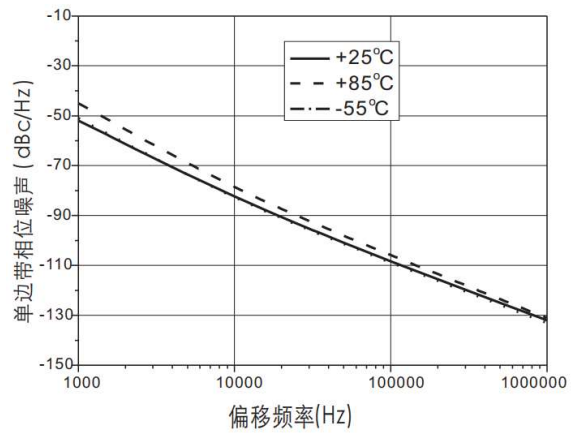

RFOUT/2 Frequency vs. Tuning Voltage
Vcc=+5V

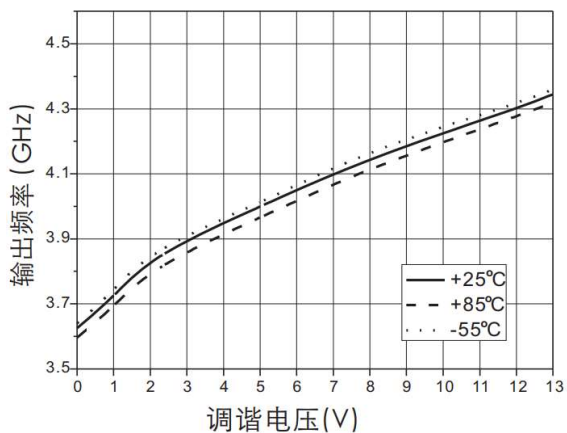

RFOUT/2 Output Power vs. Tuning Voltage
Vcc=+5V

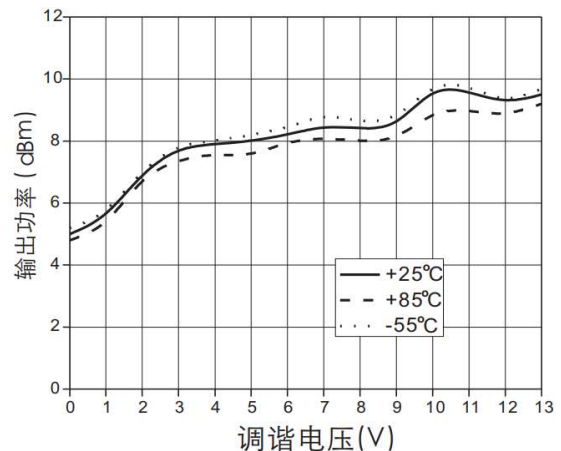

Absolute Ratings

Vcc	+5.5Vdc
Vtune	0~+15V
Junction Temperature	175°C
Storage Temperature	-65°C~+150°C
Operating Temperature	-55°C~+125°C
Static Protection	Class 1A

Typical Operating Current

Vcc(V)	ICC(mA)
4.75	160
5.0	180
5.25	200



ELECTROSTATIC SENSITIVE DEVICE
OBSERVE HANDLING PRECAUTIONS

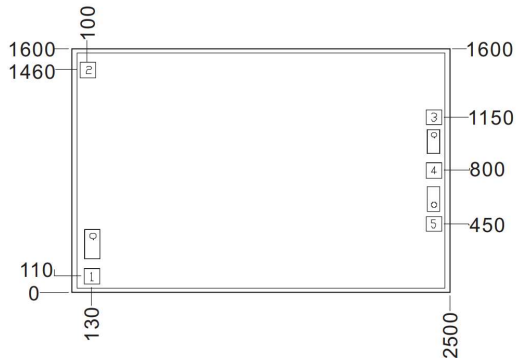

Outline Size



Note:

1. Unit: um
2. Bottom side is gold plated
3. Bottom side is GND
4. Bonding pads is gold plated, Pad size: 100*100(um)
5. Don't bonding on thru holds
6. Tolerance: ±50um

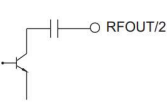
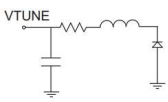
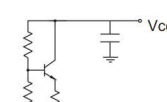
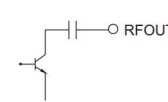
Bonding Pads Definition

Number	1	2	3,5	4	Bottom
Symbol	RFOUT/2	VTUNE	Vcc	RF OUT	GND
Description	1/2 harmonic output (block capacitor included)	Tuning Voltage port	Current port, +5V	RF output port (block capacitor included)	Bottom must be grounded
Equivalent Circuit					

Assembly Drawing

