

## Features

SAW filter for WIFI

- High stability and reliability with good performance
- Narrow and sharp pass band characteristics. RoHS compatible
- Low insertion loss and deep stop band attenuation for interference
- Low – loss SAW filter for WIFI transmission
- Package size 1.1mm\*0.9mm

## Electrical Specification

ITEM		Min.	Typ.	Max.	Unit
Insertion Loss	2403~2471 MHz		1.2	2.2	dB
Insertion Loss	2458~ 2476 MHz		1.2	1.8	dB
Insertion Loss	2463~2481 MHz		1.6	2.5	dB
Passband Ripple	2403~ 2481 MHz		0.8	2.0	dB
VSWR	2401~ 2483 MHz		1.2	2.0	
Attenuation	800~2000.00 MHz	25	27		dB
Attenuation	2000.00~2300.00 MHz	25	27		dB
Attenuation	2300.00~2370.00 MHz	27	30		dB
Attenuation	2370.00~2380.00 MHz	18	30		dB
Attenuation	2500.00~2502.00 MHz	7	42		dB
Attenuation	2502.00~2570.00 MHz	12	41		dB
Attenuation	2570.00~2620.00 MHz	29	34		dB
Attenuation	2620.00~2690.00MHz	26	31		dB
Attenuation	2690.00~4800.00 MHz	25	29		dB
Attenuation	4800.00~5825.00 MHz	27	35		dB
Attenuation	7200.00~7500.00 MHz	30	42		dB
Input / Output Impedance (Nominal)		50Ω//4.3nH			

## Maximum Ratings

Rating	Symbol	Value	Unit
DC Voltage (between any Terminals)	$V_{DC}$	10	V
RF Power (in BW)	P	29	dBm
Operating Temperature Range	$T_A$	-30 ~ +85	°C
Storage Temperature Range	Tstg	-40 ~ +85	°C
ESD Voltage (HB)	$V_{ESD}$	>150	V
Moisture Sensitivity Levels	MSL	3	

### Outline Drawing

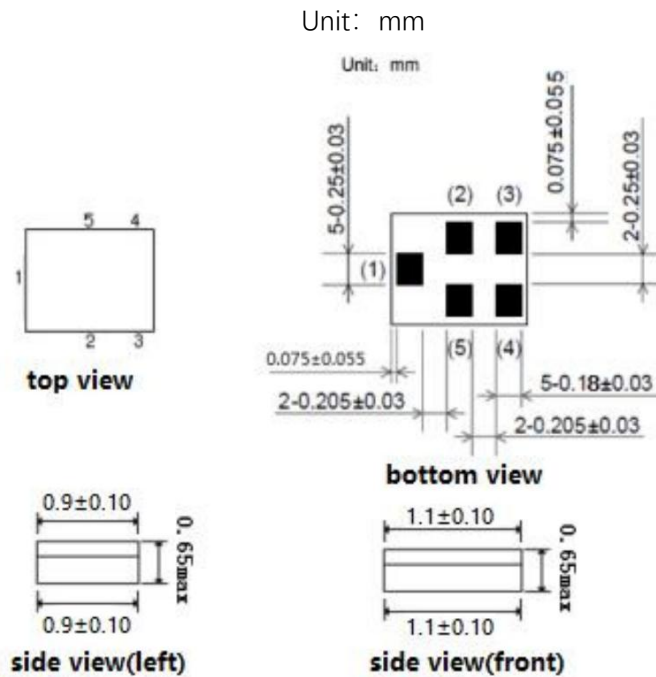

### Pin Configuration

PIN#	Description
1	Input
4	Output
2,3,5	Ground



### Marking

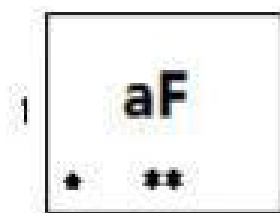

#### Top View, Laser Marking

“aF”: Part Number

“.” Dot marking, indicates input

“1”: Terminal 1

The first “\*”: Month Code (The code shown below varies in a 4-year-cycle)

Month	1	2	3	4	5	6	7	8	9	10	11	12
2016/2020	n	p	q	r	s	t	u	v	w	x	y	z
2017/2021	A	B	C	D	E	F	G	H	J	K	L	M
2018/2022	N	P	Q	R	S	T	U	V	W	X	Y	Z
2019/2023	a	b	c	d	e	f	g	h	i	j	k	m

The second “\*”: Date Code

Date	1st	2nd	3rd	4th	5th	6th	7th	8th	9th	10th	
Code	A	B	C	D	E	F	G	H	J	K	
Date	11th	12th	13th	14th	15th	16th	17th	18th	19th	20th	
Code	L	M	N	P	Q	R	S	T	U	V	
Date	21st	22nd	23rd	24th	25th	26th	27th	28th	19th	30th	31st
Code	W	X	Y	Z	a	b	d	e	f	g	h

Typical Frequency Response

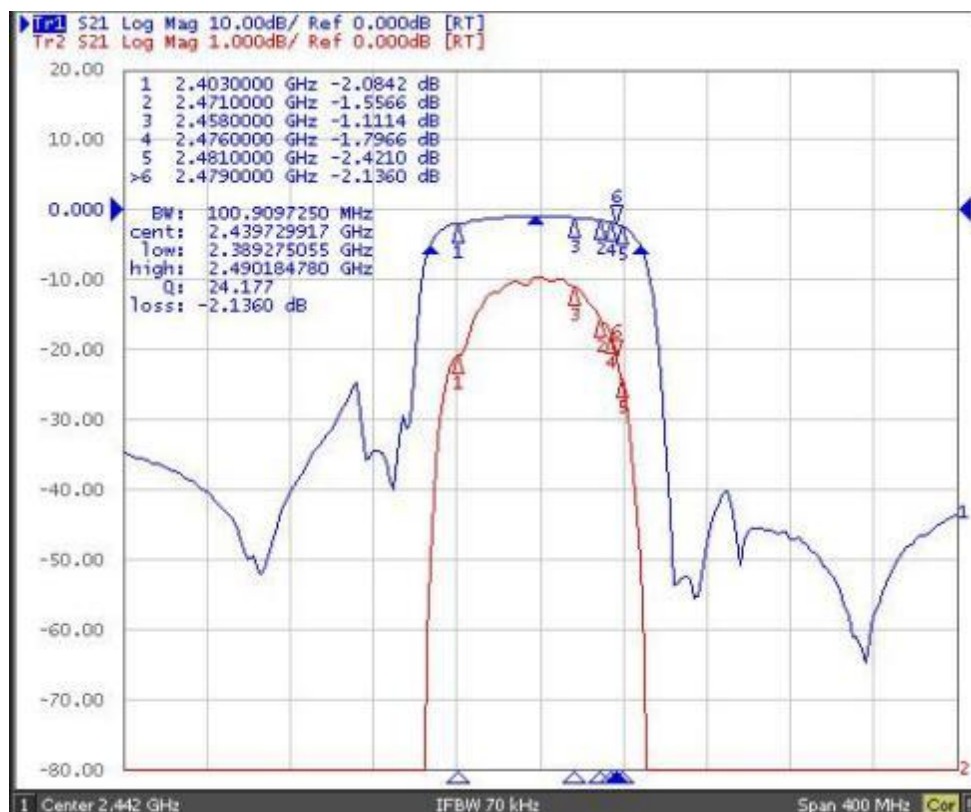

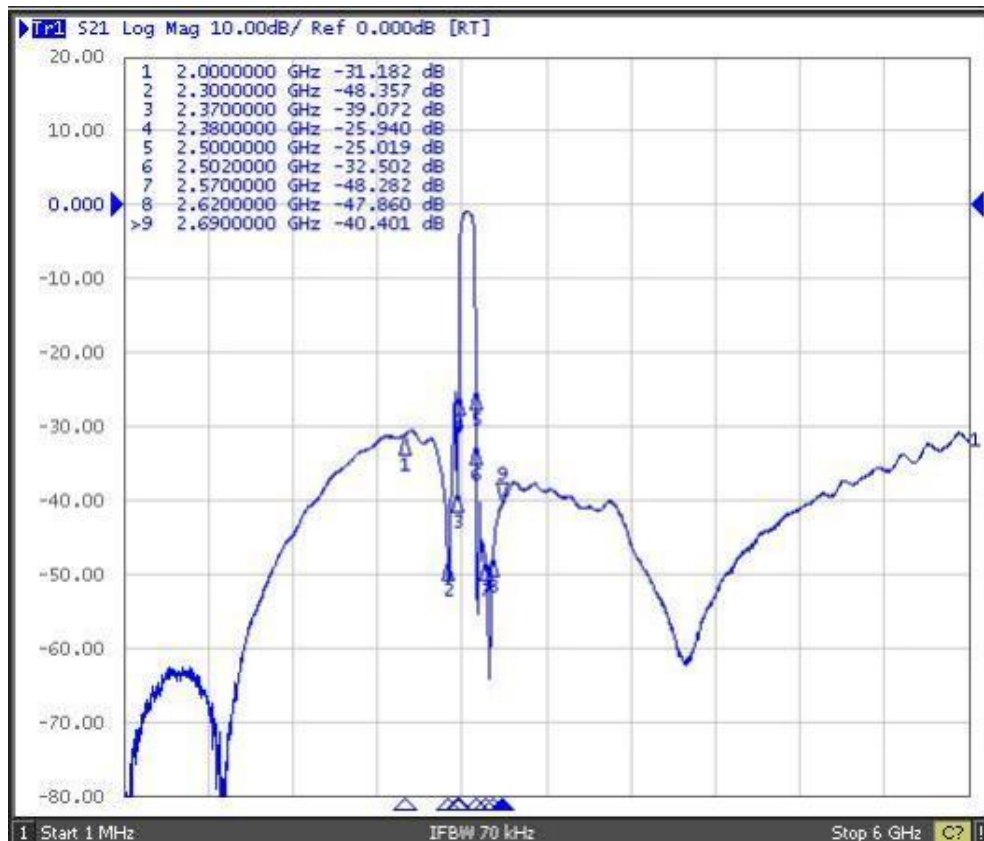
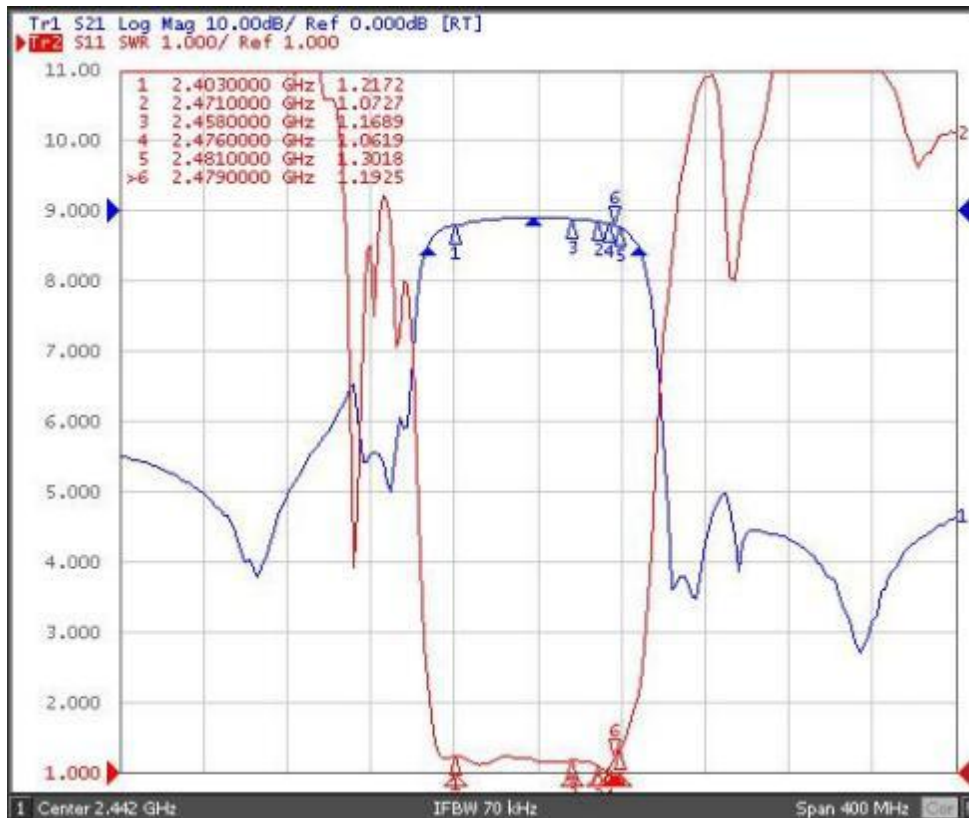

### Test Circuit

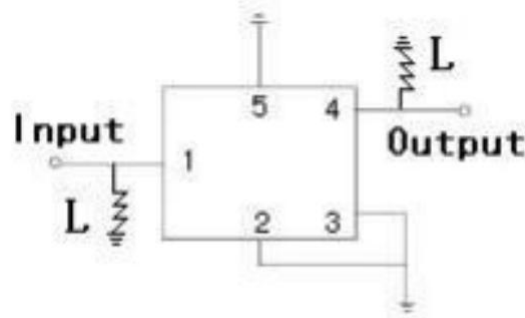

50  $\Omega$

**L=4.3 nH**

### Stability Characteristics

ITEM	Test Item	STD Reference	Test Conditions	per lot
	Preconditioning	JESD22-A113	1) Temperature Cycling, 5 cycles -40°C to 85°C; 2) Bake, 24 hrs @85±5°C; 3)Moisture Soak, Soak time and conditions per IPC/JEDEC J-STD-020 based on device MSL level; 4) Reflow, 3 reflow cycles; 5) Drying, Room ambient temperature.	All behind
1	Temperature Cycling	JESD22-A104	-40°C / +85°C ,5°C/min, 15min dwell, < 1 min transfer time,500cycles	3*25 pcs
2	High Temperature Storage	JESD22-A103	Temperature = 85°C, 1000 hours.	3*25 pcs
3	Temperature Humidity no bias	JEDEC Std A101-B	85°C 85%RH 240 hours	3*25 pcs
4	Human Body Mode ESD	JESD22-A114	Ta=25°C, ≥100V	3 pcs
5	Charge Device Mode ESD	JESD22-C101	Ta=25°C, ≥100V	3 pcs
6	Solderability	JESD22-B102	Wetting: 245°C, 5s.	22 pcs
7	Drop Test	JESD22-B111	1500 Gs, 0.5 millisecond duration, half-sine pulse.	20 pcs
8	Mechanical Shock	JESD-47	Shock pulse of 1500g with pulse duration of 0.5+/-0. 1msec (X ,Y & Z); 5 shocks per axis.	3*25 pcs

### Remarks

- SAW devices should not be used in any type of fluid such as water, oil, organic solvent, etc.
- Be certain not to apply voltage exceeding the rated voltage of components.
- Do not operate outside the recommended operating temperature range of components.
- Sudden change of temperature shall be avoided, deterioration of the characteristics can occur.
- Be careful of soldering temperature and duration of components when soldering.
- Do not place soldering iron on the body of components.
- Be careful not to subject the terminals or leads of components to excessive force.
- SAW devices are electrostatic sensitive. Please avoid static voltage during operation and storage.
- Ultrasonic cleaning shall be avoided. Ultrasonic vibration may cause destruction of components.

### Packing Information

Carrier Tape

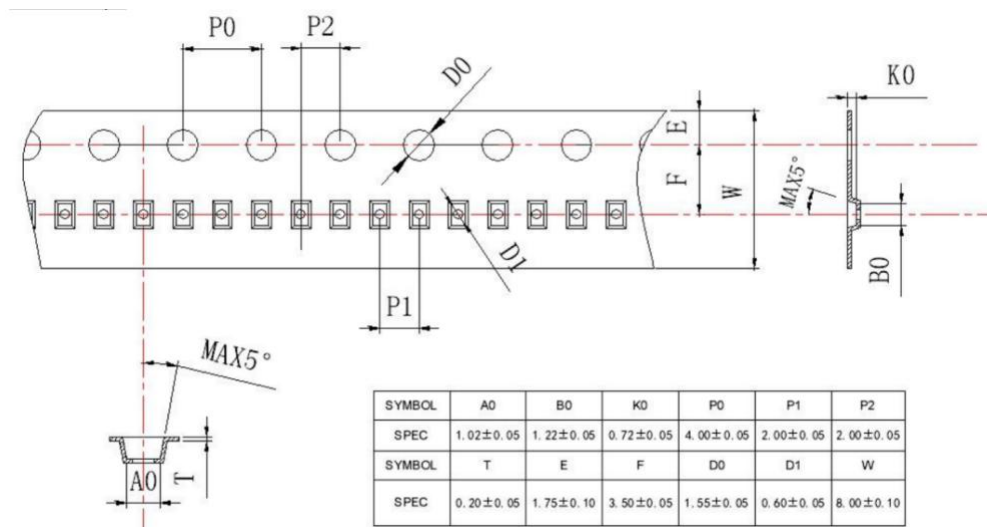

Reel Dimensions

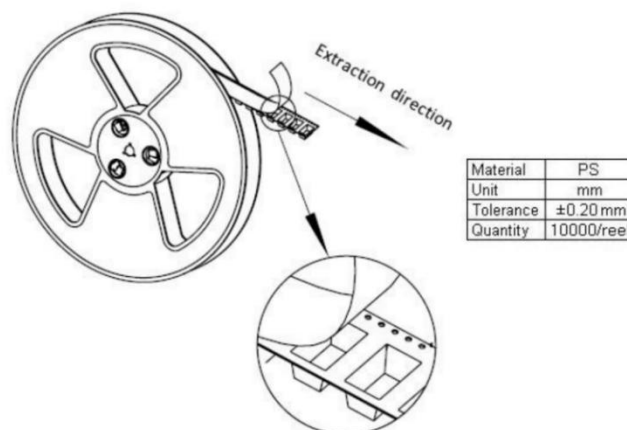

Outer Packing

Type	Quantity	Dimension	Description	Weight
Carton Box I	100000	240×210×285mm	anti-static plastic bag & carton box 1 reel / bag 10 bags / box (100000pcs)	2.15kg
Carton Box II	300000	470×310×285mm		30 bags / box (300000pcs)

Recommended Soldering Profile

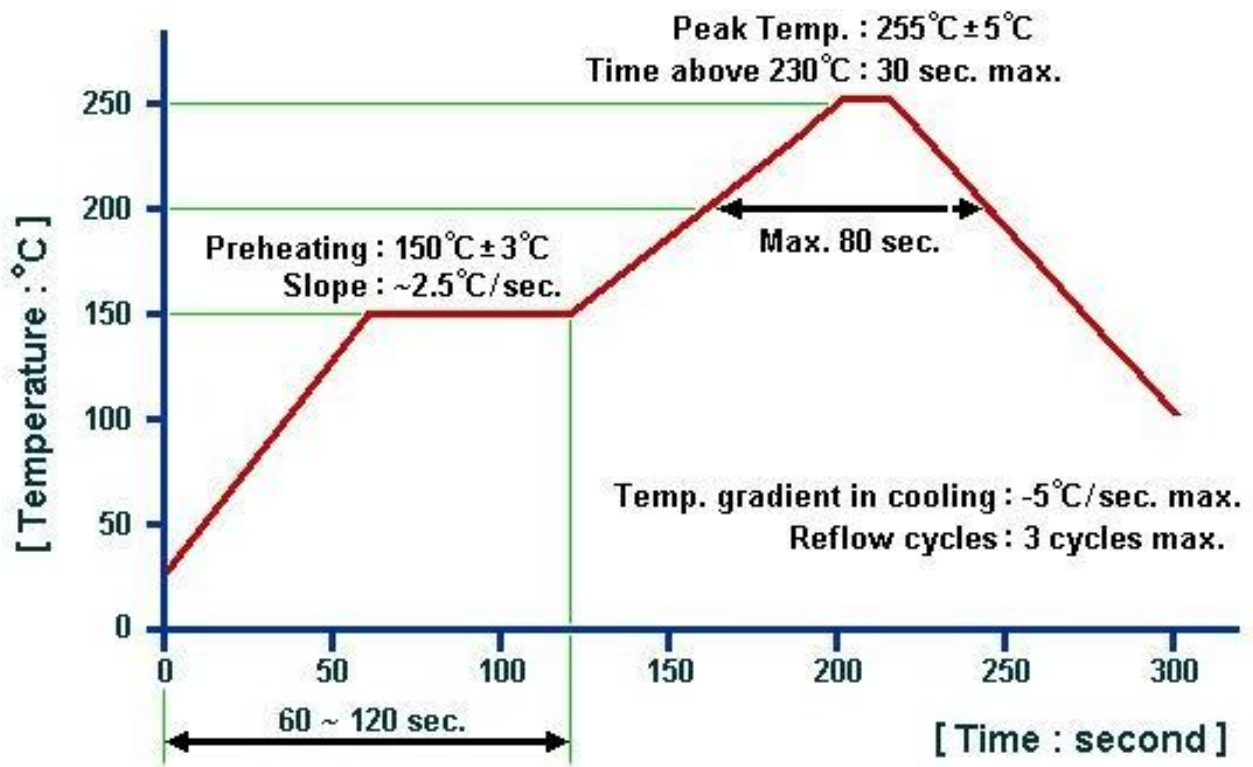

Remarks:

1. The specifications of this device are subject to change or obsolescence without notice.
2. Typically, equipment utilizing this device requires emissions testing and government approval, which is the responsibility of the equipment manufacturer.
3. Our liability is only assumed for the Surface Acoustic Wave (SAW) component(s) per se, not for applications, processes and circuits implemented within components or assemblies.
4. For questions on technology, prices and delivery, please contact our sales offices or e-mail [sales@sainty-tech.com](mailto:sales@sainty-tech.com).