



HL9491 Surface Mount Balun (1 MHz to 20 GHz)

Features and Technical Specifications

Bandwidth	3 dB, 1 MHz to 20 GHz
Amplitude Match	± 0.4 dB, poly fit ¹ , $f \leq 20$ GHz ± 1.0 dB, max, $f \leq 15$ GHz
Phase Match	$\pm 5^\circ$, $f \leq 10$ GHz, poly fit ¹
Insertion Loss	7 dB, $f = 70$ MHz, nominal
Return Loss (Single-ended)	> 10 dB, unbalanced port, $f \leq 10$ GHz > 8 dB, unbalanced port, $f \leq 15$ GHz > 5 dB, balanced ports, $f \leq 15$ GHz
Rise Time	< 20 ps
Insertion Delay	≈ 145 ps, balun only ≈ 395 ps, balun mounted to eval board
Max Input Power	1 W (+30 dBm)
Impedance	50 Ω Unbal., 2 x 50 Ω Bal.
Interface	Solderable pads, Gold ENIG
Reflow Profile	Designed to be compatible with a SAC305 thermal reflow profile: - max reflow time above 217 C is 90 seconds - peak reflow temperature is 245 C, not to be exceeded
Evaluation Board	Pre-mounted (opt. -EVAL)
Dimensions	1.1" x 0.2" x 0.13" 27.94 x 5.08 x 3.30 mm
Weight	0.8 g (0.03 oz.)
Temperature Limits	-40° to +85° C, operating
RoHS Compliant	Yes, < 0.1% lead content
REACH Compliant	Yes
Warranty	1 year, see website
NOTE 1 - Curve fit using 6th order polynomial	

PRODUCT SUMMARY

The HL9491 is a surface mountable (SMD) signal splitter and combiner that offers excellent amplitude and phase match over an industry-best bandwidth of 1 MHz to 20 GHz (3 dB).

It is suitable for use in high-speed communications systems, high-speed analog-to-digital conversion, and many other applications.

DEPLOYMENT NOTES

For ideal performance, the HL9491 should be installed on a PCB designed using the material and footprint recommended by HYPERLABS.

Contact HYPERLABS for more information on design best practices.

This device is bidirectional and can be used as a signal splitter or combiner.

If the DC voltage of the balanced or unbalanced ports is non-zero, DC blocks are required. The balanced ports (2 and 3) are DC shorted.

All measurements taken using an HL9491 balun installed on an HL9490 Evaluation Board.

EVALUATION BOARD

To order the part mounted to an evaluation board, please specify the following option:

HL9491-EVAL

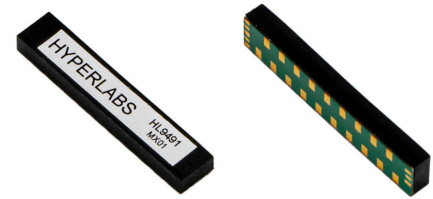

HL9491 Surface Mount Balun

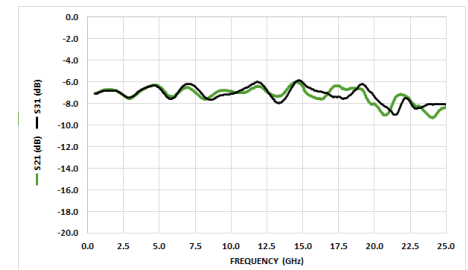

Typical HL9491 Single-ended Insertion Loss

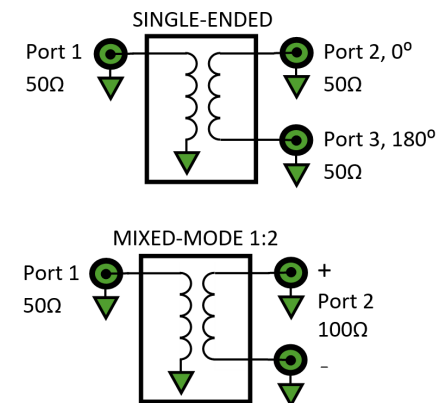

HL9491 Schematic and Port Assignments



HL9491 Single-ended Insertion Loss

Bandwidth is defined as the range of frequencies where insertion loss is within 3 dB of the 70 MHz value (nominally 7 dB single-ended, 4dB differential).

Figure 1 shows the insertion loss and amplitude match of an HL9491 in single-ended mode using a log frequency scale.

Figure 2 shows the same using a linear frequency scale.

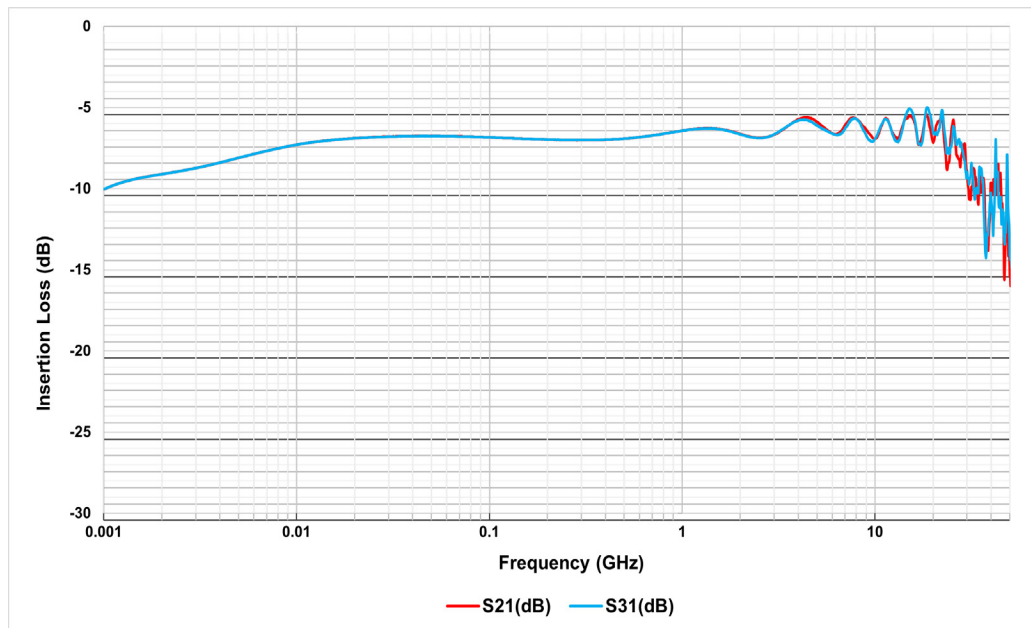

Figure 1: HL9491 Single-ended Insertion Loss - log scale

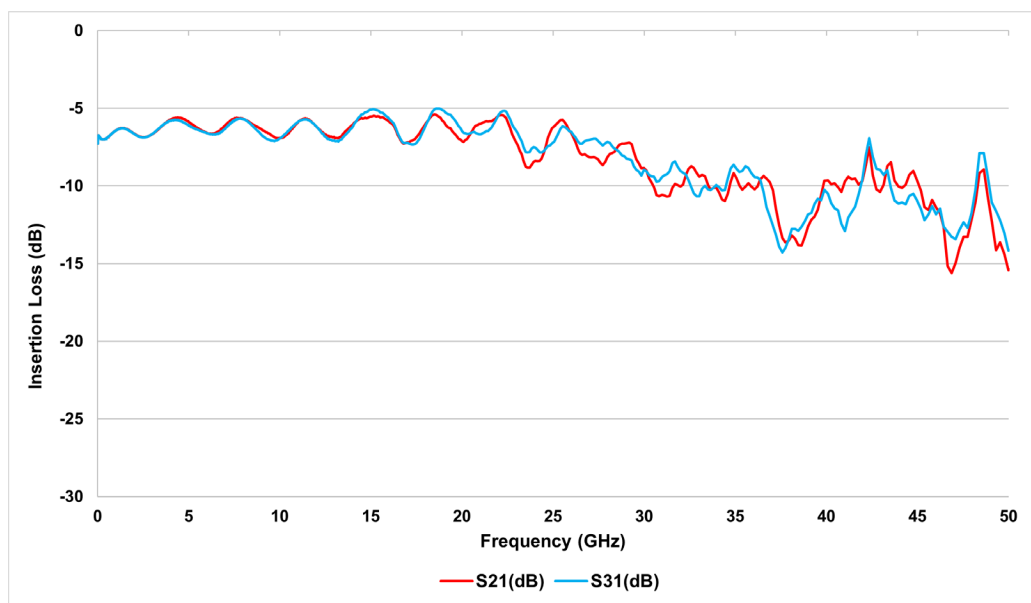

Figure 2: HL9491 Single-ended Return Loss - linear scale



HL9491 Single-ended Insertion Loss and Return Loss

Figure 3 shows the return loss of all ports in single-ended mode.

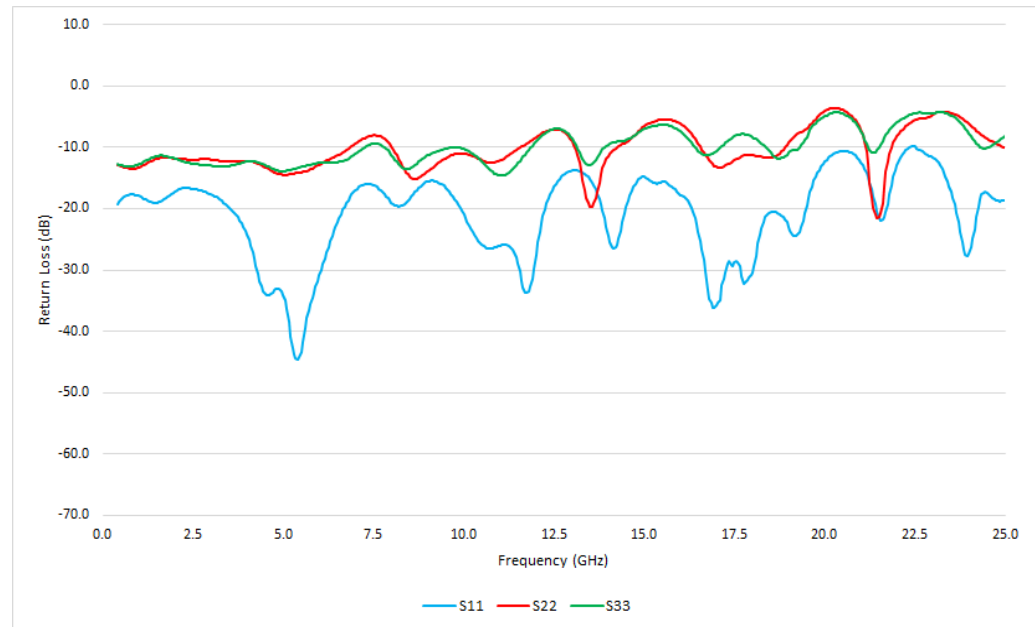

Figure 3: HL9491 Single-ended Return Loss



HL9491 Mixed-mode Insertion Loss

Mixed-mode S-parameters are useful for characterizing the performance of differential circuits such as broadband baluns.

Figures 4-5 show the insertion loss of an HL9491 balun in mixed mode to 25 GHz.

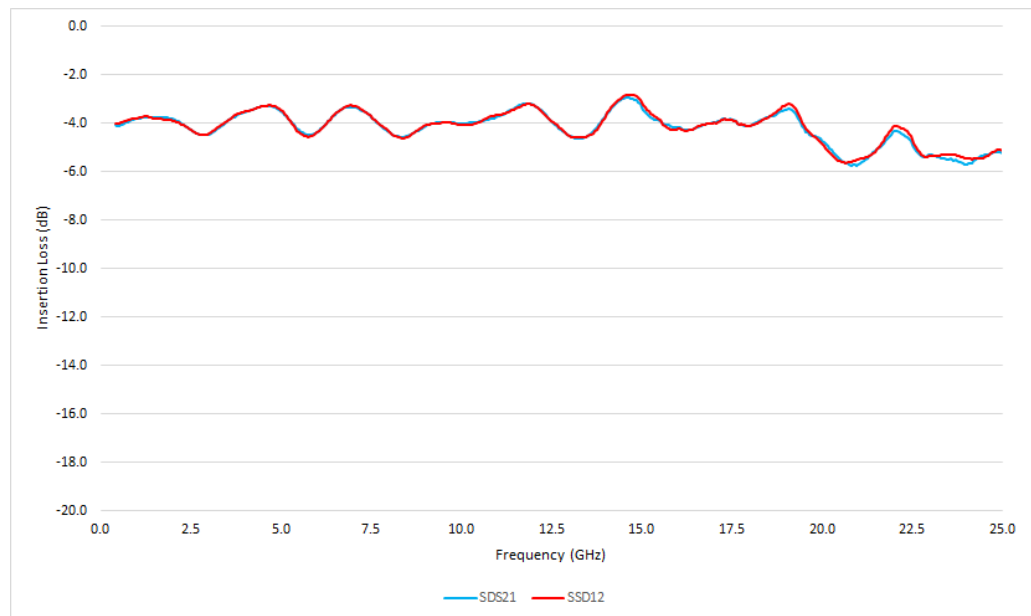

Figure 4: HL9491 Differential Mode Insertion Loss

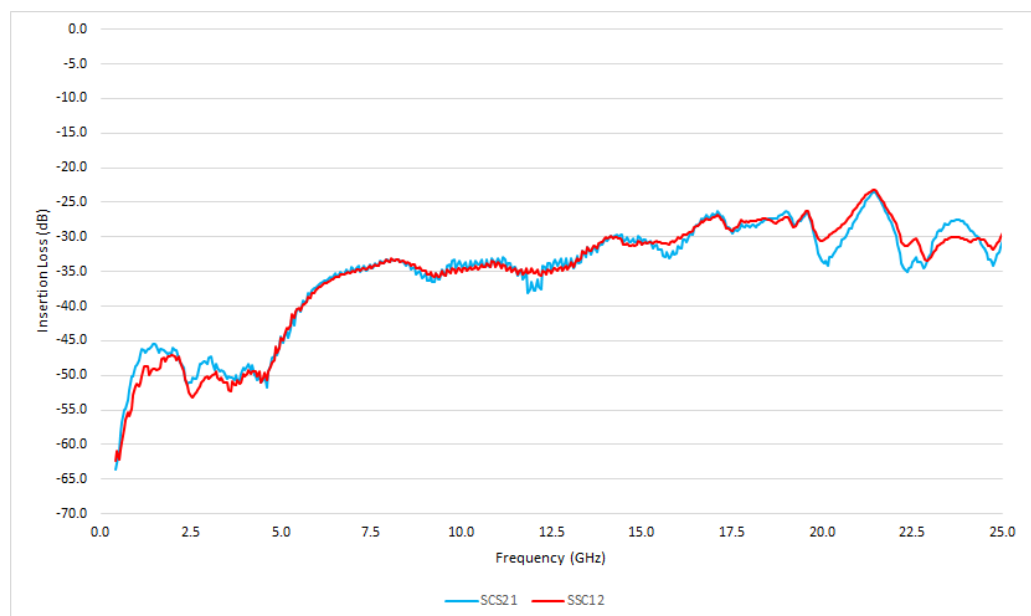

Figure 5: HL9491 Common Mode Insertion Loss

HL9491 Mixed-mode Return Loss

Figure 6 shows the typical mixed-mode return loss of the unbalanced and balanced ports of an HL9491 to 25 GHz.

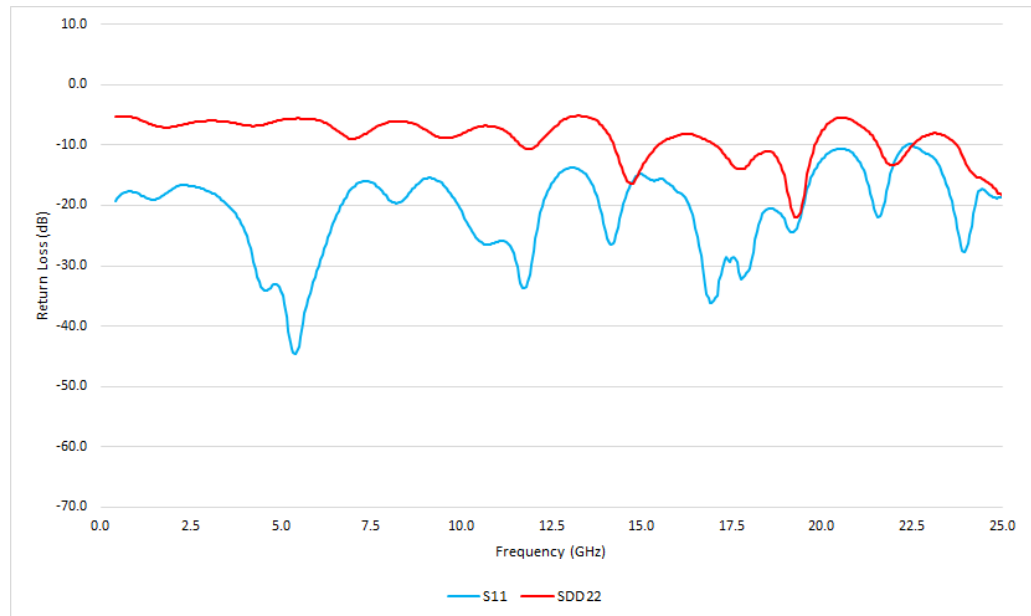

Figure 6: HL9491 Mixed-mode Return Loss

HL9491 Eye Diagrams

The eye diagrams in Figures 7-8 show a 56 Gbps PRBS11 pattern passed through an HL9491. All plots are shown at 100 mV/div.

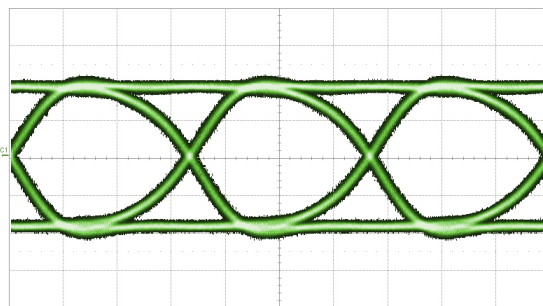

Figure 7: HL9491 56 Gbps PRBS 11, RF Input

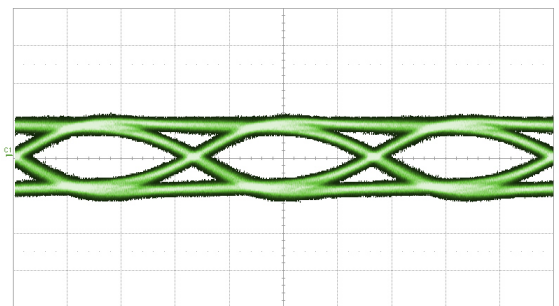

Figure 8: HL9491 56 Gbps PRBS 11, RF Output



HL9491 Group Delay and Phase Match

Figure 9 shows the typical group delay of an HL9491 used as a signal splitter. The average slope of the phase mismatch, shown in Figure 10, is equal to the group delay mismatch.

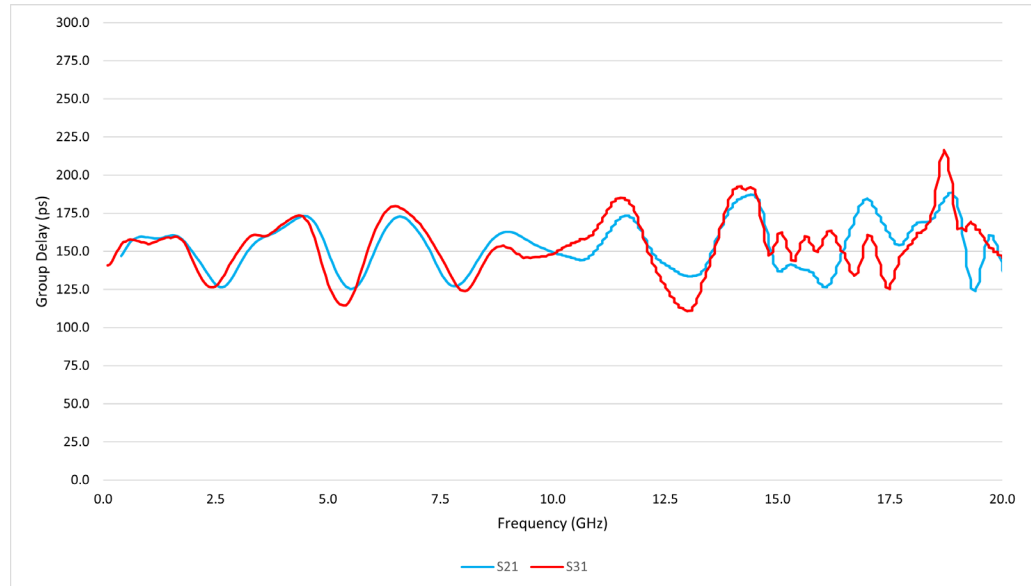

Figure 9: HL9491 Single-ended Group Delay

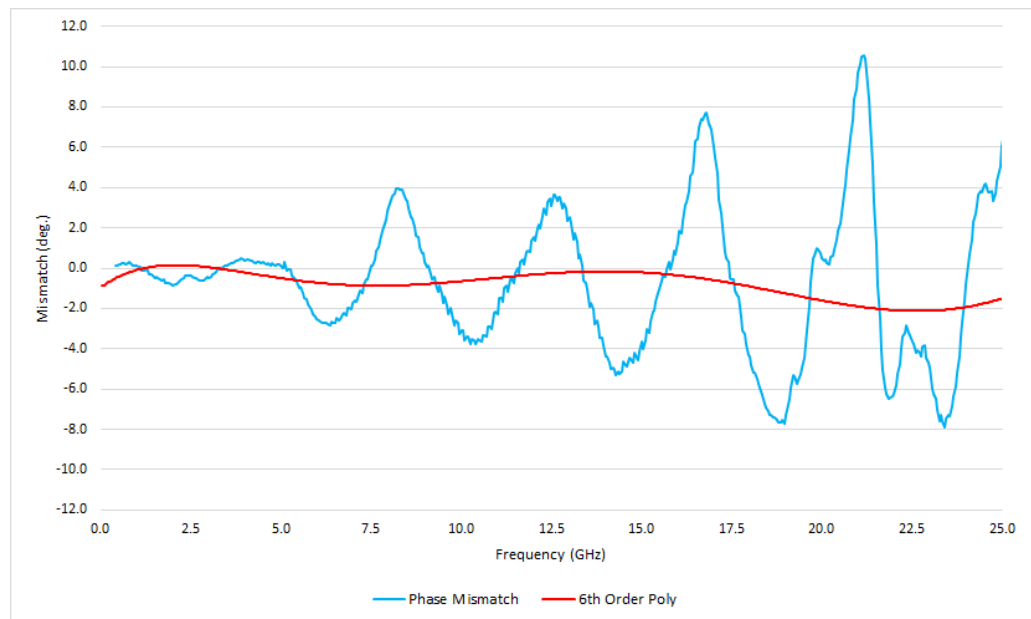

Figure 10: HL9491 Phase Mismatch

HL9491 Footprint

Figure 11 shows the recommended footprint of an HL9491. Unless otherwise noted, all units are in inches. Other models vary in width based on connectors.

Figure 12 shows a drawing of the HL9490 Evaluation Board, available mounted with the HL9491 as Opt. -EVAL.

The HL9491 is designed to be compatible with the SAC305 thermal reflow profile. See the specs on Page 1 for specific temperatures.

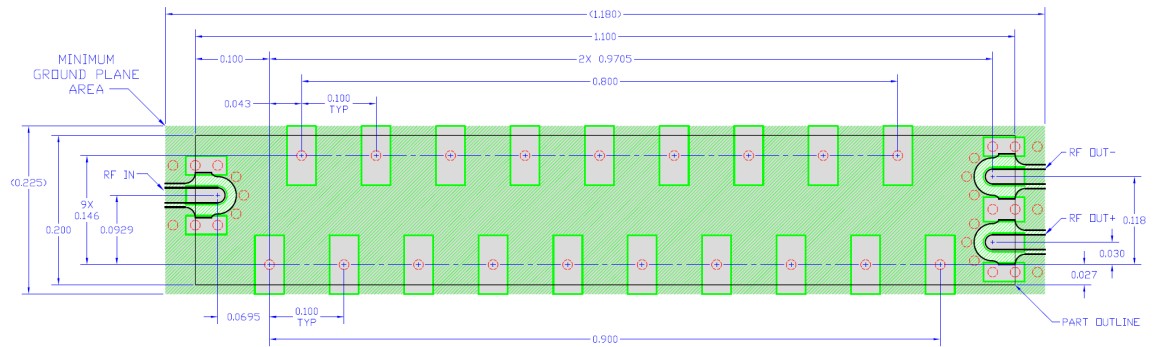
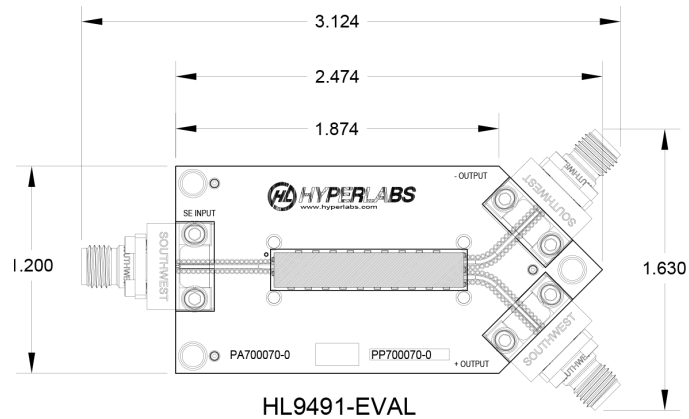

Fig. 11: HL9491 Recommended Footprint



HL9491-EVAL

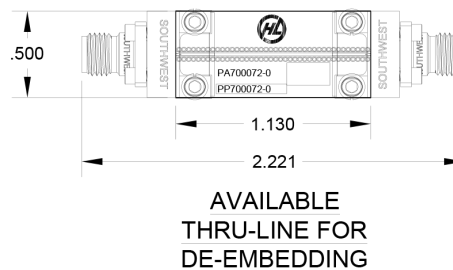

Fig. 12: HL9491-EVAL Evaluation Board