



HL9492 Surface Mount Balun (5 MHz to 30 GHz)

Features and Technical Specifications

Bandwidth	3 dB, 5 MHz to 30 GHz
Amplitude Match	± 0.4 dB, poly fit ¹ , $f \leq 20$ GHz ± 1.0 dB, max, $f \leq 15$ GHz
Phase Match	$\pm 5^\circ$, $f \leq 10$ GHz, poly fit ¹
Insertion Loss	8 dB, $f = 70$ MHz, nominal
Return Loss (Single-ended)	> 10 dB, unbalanced port, $f \leq 10$ GHz > 8 dB, unbalanced port, $f \leq 15$ GHz > 5 dB, balanced ports, $f \leq 15$ GHz
Rise Time	< 20 ps
Group Delay	≈ 75 ps, balun only ≈ 325 ps, balun mounted to eval board
Max Input Power	1 W (+30 dBm)
Impedance	50 Ω Unbal., 2 x 50 Ω Bal.
Interface	Solderable pads, Gold ENIG
Reflow Profile	Designed to be compatible with a SAC305 thermal reflow profile: - max reflow time above 217 C is 90 seconds - peak reflow temperature is 245 C, not to be exceeded
Evaluation Board	Pre-mounted (opt. -EVAL)
Dimensions	0.5" x 0.2" x 0.13" 12.7 x 5.08 x 3.30 mm
Weight	0.6 g (0.2 oz.)
Temperature Limits	-40° to +85° C, operating
RoHS Compliant	Yes, < 0.1% lead content
REACH Compliant	Yes
Warranty	1 year, see website
NOTE 1 - Curve fit using 6th order polynomial	

PRODUCT SUMMARY

The HL9492 is a surface mountable (SMD) signal splitter and combiner that offers excellent amplitude and phase match over an industry-best bandwidth of 3 MHz to 30 GHz (3 dB).

It is suitable for use in high-speed communications systems, high-speed analog-to-digital conversion, and many other applications.

DEPLOYMENT NOTES

For ideal performance, the HL9492 should be installed on a PCB designed using the material and footprint recommended by HYPERLABS.

Contact HYPERLABS for more information on design best practices.

This device is bidirectional and can be used as a signal splitter or combiner.

If the DC voltage of the balanced or unbalanced ports is non-zero, DC blocks are required. The balanced ports (2 and 3) are DC shorted.

All measurements taken using an HL9492 balun installed on an HL9490 Evaluation Board.

EVALUATION BOARD

To order the part mounted to an evaluation board, please specify the following option:

HL9492-EVAL

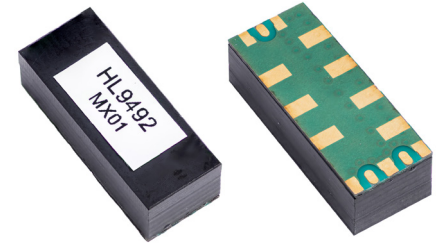

HL9492 Surface Mount Balun

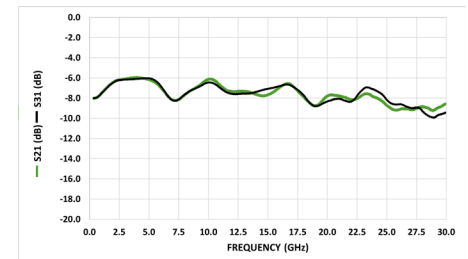

Typical HL9492 Single-ended Insertion Loss

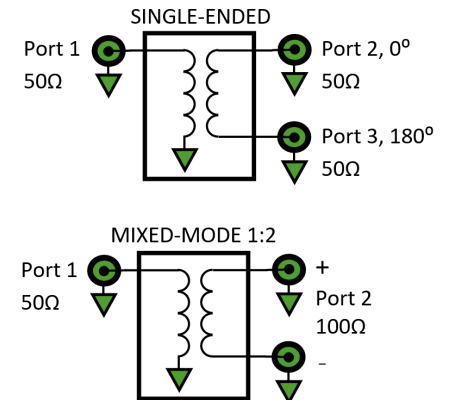

HL9492 Schematic and Port Assignments



HL9492 Single-ended Insertion Loss

Bandwidth is defined as the range of frequencies where insertion loss is within 3 dB of the 70 MHz value (nominally 8 dB single-ended, 5 dB differential).

Figure 1 shows the insertion loss and amplitude match of an HL9492 in single-ended mode using a log frequency scale.

Figure 2 shows the same using a linear frequency scale.

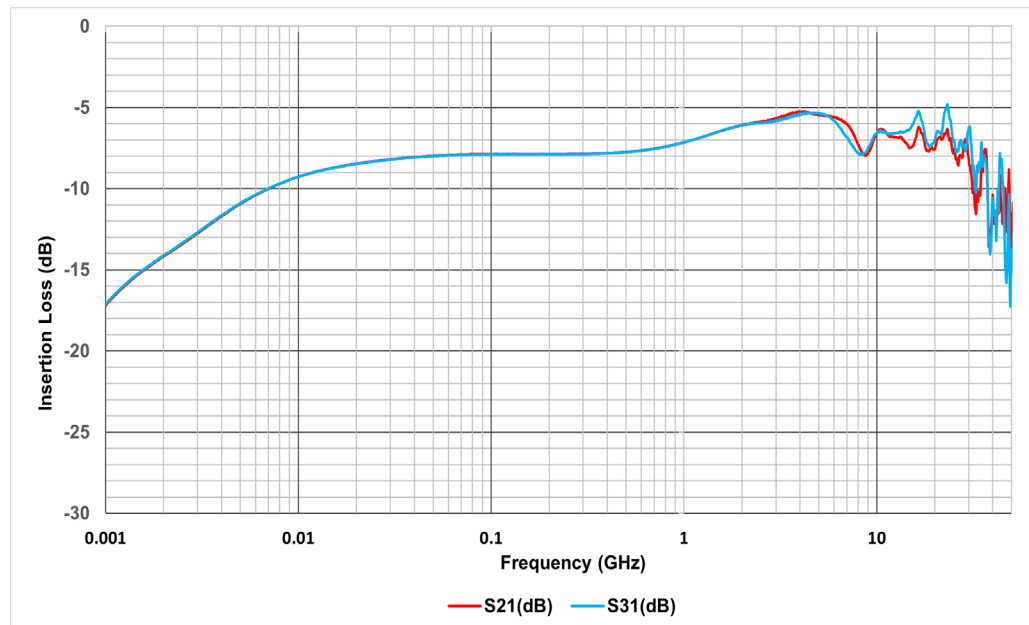

Figure 1: HL9492 Single-ended Insertion Loss - log scale

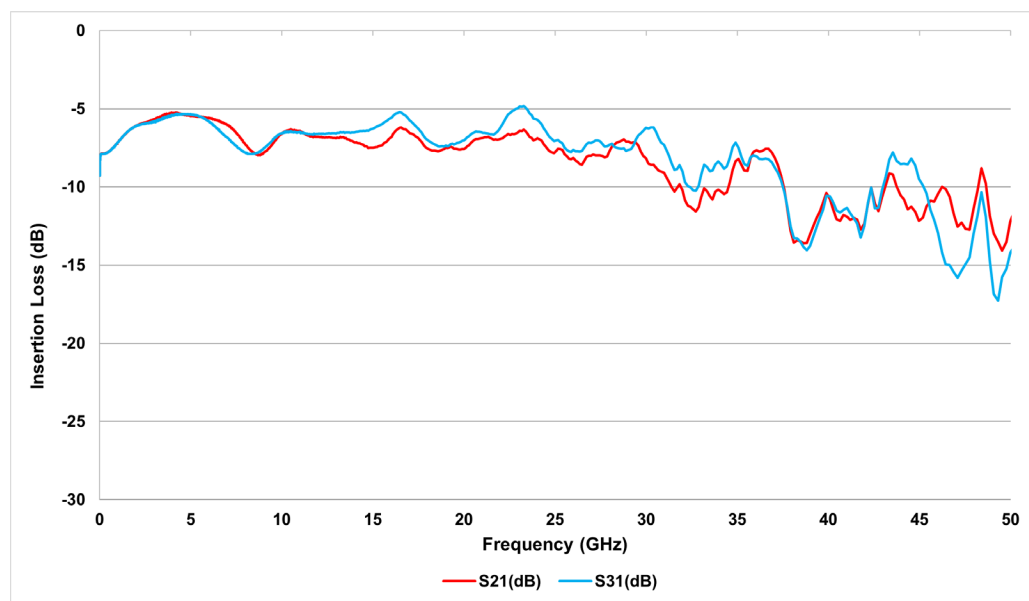

Figure 2: HL9492 Single-ended Insertion Loss - linear scale



HL9492 Single-ended Return Loss

Figure 3 shows the typical mixed-mode return loss of the unbalanced and balanced ports of an HL9492 to 30 GHz.

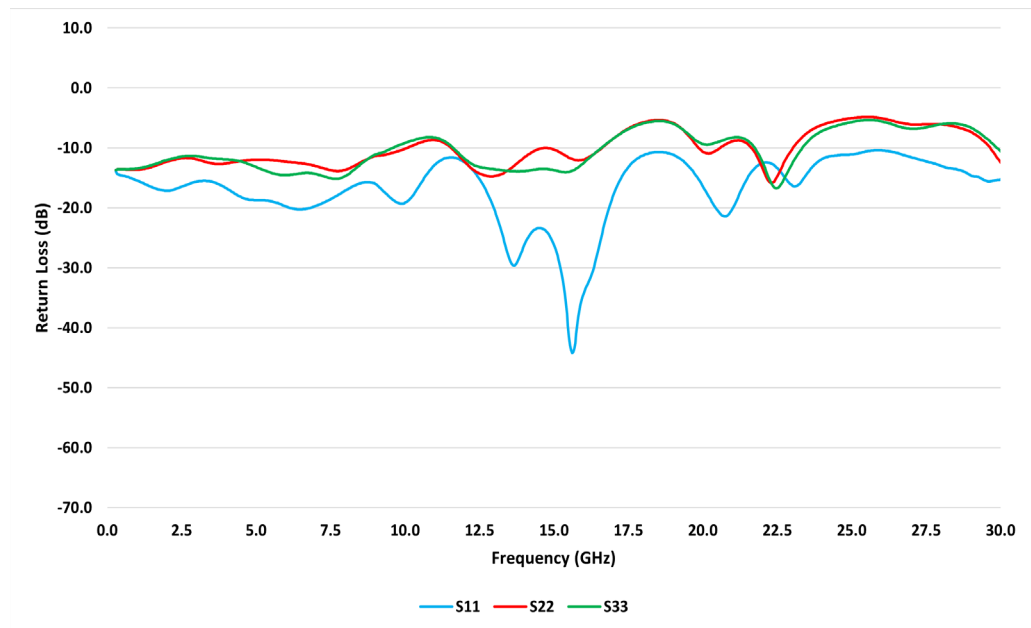

Figure 3: HL9492 Single-ended Return Loss

HL9492 Eye Diagrams

The eye diagrams in Figures 4-5 show a 56 Gbps PRBS11 pattern passed through an HL9492. All plots are shown at 100 mV/div.

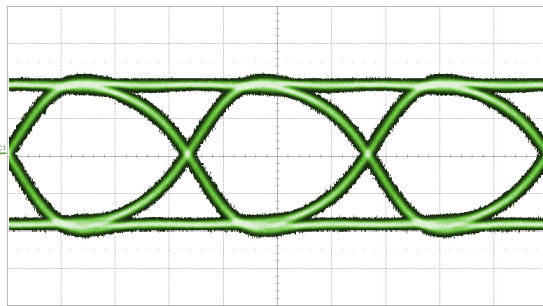

Figure 4: HL9492 56 Gbps PRBS 11, RF Input

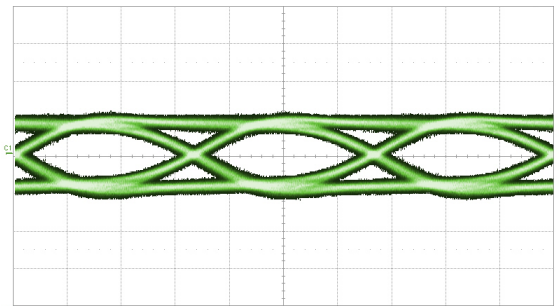

Figure 5: HL9492 56 Gbps PRBS 11, RF Output



HL9492 Group Delay and Phase Match

Figure 6 shows the typical group delay of an HL9492 used as a signal splitter. The average slope of the phase mismatch, shown in Figure 7, is equal to the group delay mismatch.

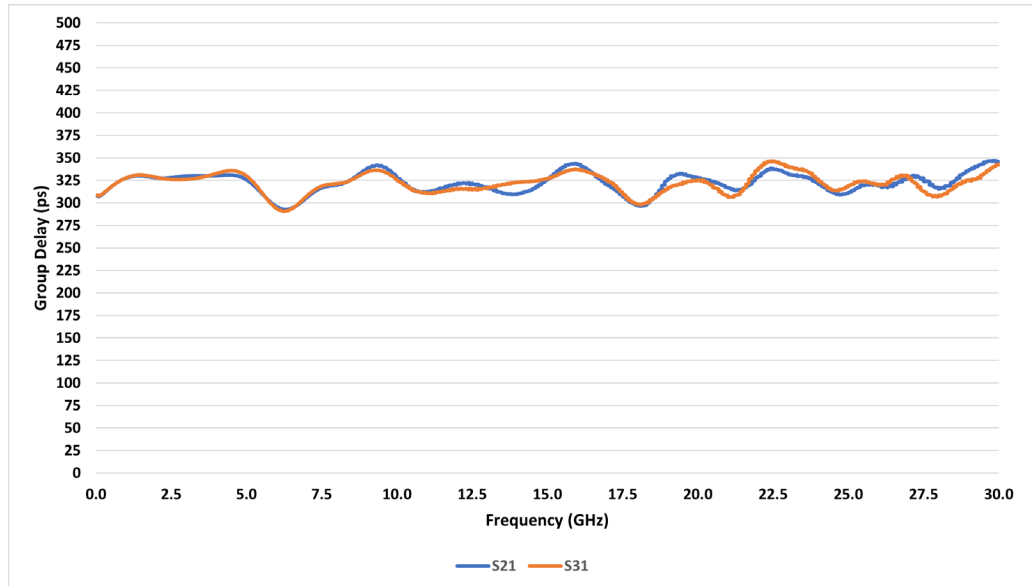

Figure 6: HL9492 Single-ended Group Delay (with Evaluation Board)

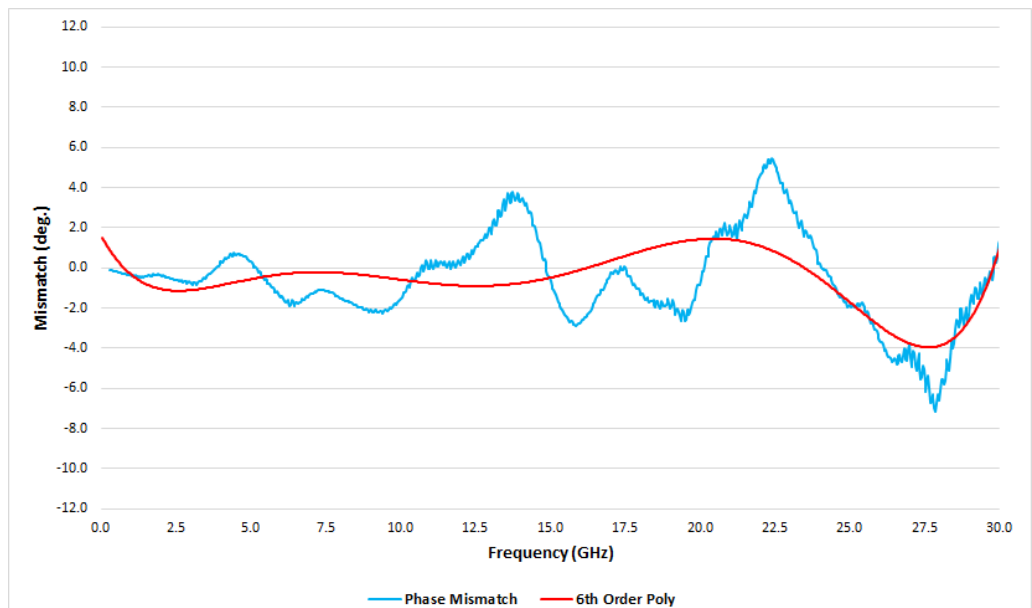

Figure 7: HL9492 Phase Mismatch

